



*Quality at sea*

RP  
DFP  
CFP

Manual / Handbuch

Spare parts list / Ersatzteilliste



**WESCO Navy** • Equipment Imp.-Exp. GmbH • Zitterpappelweg 9  
D - 22391 Hamburg • Tel.: + 49 40 60009468-0 • Fax: + 49 40 536 75 01  
E-Mail: [info@wesco-navy.com](mailto:info@wesco-navy.com) • [www.wesco-navy.com](http://www.wesco-navy.com)

THESE INSTRUCTIONS ARE FOR MARINE CABINETS MR, MF AND MRF 2/2.

IT IS VERY IMPORTANT TO READ THESE INSTALLATION AND OPERATING INSTRUCTIONS CAREFULLY BEFORE YOU START USING THE EQUIPMENT FOR THE FIRST TIME.

ALSO, PLEASE KEEP THESE INSTRUCTIONS IN A SAFE PLACE FOR FUTURE REFERENCE OR USE BY ANOTHER OPERATOR.

BY FOLLOWING THESE INSTRUCTIONS YOU CAN IMPROVE THE PRODUCT'S PERFORMANCE AND REDUCE UNNECESSARY REPAIR COSTS. PLEASE NOTE! IT IS IMPORTANT TO HAVE YOUR EQUIPMENT REGULARLY MAINTAINED BY A PROFESSIONAL ENGINEER.

YOU WILL FIND THE TERMS OF GUARANTEE ON PAGE 6.

## TABLE OF CONTENTS

RECEIPT	2
INSTALLATION AND INTRODUCTION	2
USE: COMBINED CONTROLLER AND DIGITAL TEMPERATURE DISPLAY	3
-keyboard	3
-to lock and unlock the keyboard	3
-display lights	3
-main switch	4
-defrosting	4
-manual defrosting	4
-to check the lowest temperature	4
-to check the highest temperature	4
-to delete the lowest and highest temperatures registered	4
-to modify the temperature set points	4
ALARM SIGNALS	5
CLEANING TO BE UNDERTAKEN BY THE OPERATOR	6
IF THE CABINET DOES NOT FUNCTION CORRECTLY	6
DISPOSAL OF THE EQUIPMENT	6
GUARANTEE	6
SERVICE DURING GUARANTEE PERIOD	6

## RECEIPT

Check the product as soon as you receive it. If you notice that it has suffered from damages during transportation, you must indicate this in the delivery documents and tell about the matter to the carrier off the retailer.

**The manufacturer's guarantee does not cover damages caused by transportation!**

## INSTALLATION AND INTRODUCTION

Unpack the cabinet as close to the installation place as possible.

Remove the protective films on exterior surfaces of the cabinet.

Sort packing material and dispose off according to local legislation requirements.

Avoid placing the cabinet in direct sunlight or close to any equipment radiating heat, such as cookers and radiators.

The ambient temperature must be +5°C...+32°C.

Ensure the cabinet is horizontal (if necessary use spirit level). The legs are adjustable. All legs must touch the floor with even weight loading per leg.



Fasten the cabinet on the floor through Ø9 mm bolt holes of the foot flange. You can also weld the flange on the floor. The height of the legs can be adjusted after the cabinet has been fastened on the place.

Ensure the air circulation below and above the cabinet is free. Leave 10 cm empty space above the cabinet.

Clean the unit carefully with a mild detergent prior to use, for instance dish washing liquid. **Do not use scrubbing products, abrasive materials or chlorine based products i.e. bleach when cleaning!**

Unpack the shelf packages and put the shelves in place.



If the unit has been outside and is then brought inside for any period there will be condensate water on the units surface. **Do not connect the machine to an electric inlet before the surfaces are dry and the surface has reached room temperature!**

**Connect the unit to an earthed electrical socket of 230 V / 50 Hz this being protected by an independent fuse of a 16 amp rating.**

Let the cabinet stand at least 2 hours on the installation place before switching it on so that the compressor lubricating oil gets down into the oil pocket.

Marine cabinets are designed for storing of already cool or frozen products. **Do not fill the cabinet before the necessary operating temperature inside the cabinet has been reached.**







**It is extremely important to keep foods with high acidity such as pickles and salad dressings in air tight containers. Highly acid foods will corrode the evaporator resulting in expensive repair work which will not be covered by warranty!**

**The product must not be used outdoors.**



USE: COMBINED CONTROLLER AND DIGITAL TEMPERATURE DISPLAY

**Keyboard**











-  The key to display and adjust the set point. By using the "SET" button you can modify the set point with arrow buttons (within the limits programmed in the thermostat). In the programming mode the adjusting function is quitted by this key.
-  The key shows the highest thermostat value registered. In the programming mode you navigate inside the program or it is used to raise the selected value.
-  The key shows the lowest thermostat value registered. In the programming mode you navigate inside the program or it is used to lower the selected value.
-  The manual defrosting starts when you push the key for 3 seconds.
-  Light switch
-  Power switch (Note! The power operation light remains illuminated even when power is switched off)

**Locking and unlocking the keys**

 +  The key-lock prevents unintended use of the keys. The lock is switched on and off by holding the keys down at the same time for 3 seconds. The display momentarily shows letters "PoF". With key-lock on you can still check the lowest and highest temperature registered. The light switch function can still be used when keypad is locked. "Pon" means that the keys are not locked.

**Display lights**



Symbol	Mode	Function
	FLASHING	Set temperature is displayed and can be changed.
	ON	Compressor is running.
	FLASHING	Time delay to protect compressor after start-up
	ON	The fan of the evaporator is on.
	ON	Defrosting of the evaporator is on.
	FLASHING	Drying of the evaporator is on.
	-	NOT IN USE
	ON	ALARM, see alarms on page 5.
	ON	Light is on. (Note! only in cabinets equipped with light).

**Note!**

The manual defrosting resets the defrosting time counter so that by means of the manual defrosting period the regular defrosting periods can be scheduled to take place e.g. outside the peak periods.

**Note!**

After the first start reset the lowest and highest temperatures stored.

**Note!**

The temperature of the MR cabinet can be changed from +3°...+15°C and the temperature of the MF cabinet can be changed from -15°...-25°C.

**Main switch**

The cabinet is switched on and off by using the main switch . When you move to the standby mode the code "OFF" is displayed. In the standby mode all the control functions are off. If the product is connected to the monitoring system it does not receive control or alarm data from the monitoring unit. The light switch functions when the instrument is on standby.

**Defrosting**

The evaporator is defrosted automatically. During the defrosting period the defrostings LED  is displayed. After that the display returns to the normal mode.

**Manual defrosting**

Push  key for 3 seconds when the manual defrosting will start. After manual defrost the cabinet will continue to defrost at regular intervals. Manual defrosting is recommended if there is a lot of ice on the evaporator, i.e. if the door has been left open for a long time or if warm uncovered food has been placed in the cabinet.



**To check the lowest temperature**

Push  key. Code "Lo" is displayed after which the lowest registered temperature is displayed. The display returns to the normal mode automatically after 5 seconds.





**To check the highest temperature**

Push  key. Code "Hi" is displayed after which the highest registered temperature is displayed. The display returns to the normal mode automatically after 5 seconds.

**To delete the lowest and highest temperatures registered**

The registered lowest and highest temperatures are deleted separately. Get the lowest and highest temperature registered on the display by pushing the arrow key  or . Push immediately the  key for 3 seconds until the code "rST" (reset) starts to flash on the display. Release the key and the temperatures have been deleted and the display returns to the normal mode.

**To modify the temperature set points**

Push  key and the temperature set point appears and symbol  flash on the display. Modify the value by pushing  or  key within 15 seconds. Save the new value by pushing  key again or wait for 15 seconds after which the display returns to the normal mode.



Reset the alarm signal by pushing  key.



## ALARM SIGNALS

### CODE REASON

**"HA"** **High temperature alarm**  
The temperature inside the cabinet has exceeded the set alarm temperature. The alarm can be instigated by sudden icing of the evaporator. Initiate manual defrosting (see instructions on page 4). Ensure the cabinet has not been loaded with warm products. Check that a door has not been left open. Check if product is blocking air circulation within the cabinet.

**"LA"** **Low temperature alarm**  
The temperature inside the cabinet has fallen below the set value. Ensure that the products put into the cabinet are not too cold.

**The temperature alarm is reset automatically after the interior of the cabinet returns to set temperature range. If this does not happen, move the products to another cabinet and contact your service provider.**

**"HA2"** **Condenser high temperature alarm**  
The condenser / filter needs to be cleaned. Switch the cabinet to standby mode, remove cover and clean the filter by washing and / or using a soft brush and vacuum cleaner. Remove dirt and debris from the condenser face. Check also that air circulation to the condenser is not blocked or that the ambient temperature is not too high. If the alarm still does not stop, remove products to another cabinet and contact you service provider.

**"LA2"** **Condenser low temperature alarm**

**"P1"** **Thermostat probe failure\***

**"P2"** **Evaporator probe failure\***

**"P3"** **Condenser probe failure\***

**\*Note! The cabinet operates on its standby system and will hold normal temperature, but reset the alarm signal and immediately contact your service provider.**

## CLEANING TO BE UNDERTAKEN BY THE OPERATOR

Switch the power off.

**Do not use running water to wash the cabinet.**

Clean the stainless steel surfaces using a mild water soluble detergent, for example washing up liquid. **Do not use scrubbing products, abrasive materials or chlorine based products i.e. bleach when cleaning!**

Clean the door sealing using a mild water-soluble detergent, for instance dish washing liquid or other suitable detergent. **Do not use solvents or sharp tools!**

Use silicone to make the sealings flexible and dirt-repellent.

Clean the condenser filter twice a month. Remove the filter and rinse under running water.

Neglect of operators / user's obligations may lead to lowering of the cooling unit capacity, it's running costs and eventually damage to the equipment it's self which may not be covered under warranty.

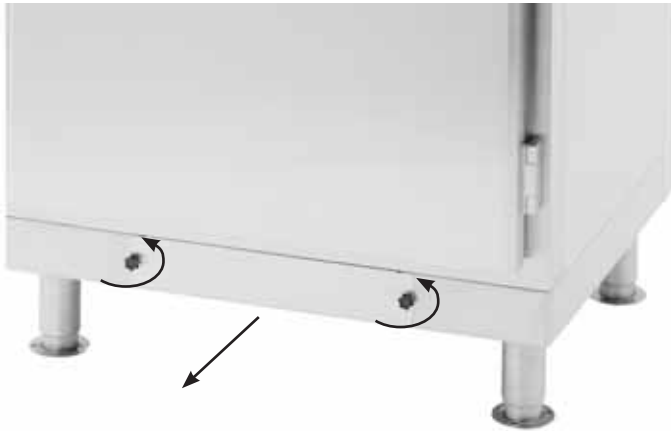

Condenser filter

## IF THE CABINET DOES NOT FUNCTION CORRECTLY

**The machine does not start**

Check that the main switch  has been turned to ON and that the indicator light of the switch is on (page 4).

Check that the electric cable has been connected to a socket.

Check that the fuse of the socket is undamaged.

**The cabinet does not become cool or does not reach the wanted temperature**

Check that the main switch  has been turned to ON and that the indicator light of the switch is on (page 4).

Check that the electric cable has been connected to a socket.

Check that the fuse of the socket is undamaged.

Check that the thermostat has been correctly adjusted (page 4, to modify the temperature set points).

Check that the ambient temperature is not too high.

Check that the filter of the condenser is not blocked (page 6).

Ensure the air circulation under and above the cabinet is free.

Check the alarm signals of the display which are detailed on page 5.

## DISPOSAL OF THE EQUIPMENT

Once the equipment becomes redundant it may not be disposed of with normal waste because the equipment is governed by the WEEE directive. It has to be disposed of following the WEEE act which became effective on August 13th 2005.

## GUARANTEE

12 months parts only guarantee. In addition a 12 months parts and labour guarantee and maintenance contract can be provided by your authorised dealer.

*The guarantee does not cover faults caused by*

- transportation
- overloading or user's negligence
- negligence due to not reading manuals, proper care and maintenance
- modifications or repairs performed by an unauthorised service agent or dealer
- use of parts not supplied or approved by the manufacturer

*The guarantee also does not cover*

- scratches / marks or dents or other minor faults caused when unpacking or during installation that do not effect the operation or performance of the equipment

**The manufacturer or his distributor or dealer or selling agent do not accept under any circumstances liability for any food loss or consequential loss how so ever it occurs.**

All goods are supplied under our terms and conditions of sale, a copy of which will be supplied on request.

## SERVICE DURING GUARANTEE PERIOD

When claiming guarantee work, please provide the manufacturers model number which can be found on the name plate attached to the inner frame of the unit towards the upper left-hand side behind the door.



27.4.2007

VARA NRO	NIMIKE	NIMI	ARTICLE	YKS	200	300	400	550
2-1-1	MA1191	HYGIENIAKATTO MARINE KAAPIT	HYGIENIC TOP SEALING	kpl	1	1	1	1
2-1-2	MA1038	SIVUVERHOLEVY KONETILA HKP MAR	UPPER SIDE PANEL	kpl	2	2	2	2
2-1-52	MA1137	HYLLYNKANNATIN MARINE	SHELF HOLDER	kpl	4	4	8	8
2-1-50-1	MA1136	HYLLYNSÄÄTÖKISKO 300 MARINE	SHELF ADJUSTMENT RAIL 300	kpl		4		
2-1-50-2	MA1135	HYLLYNSÄÄTÖKISKO 400 MARINE	SHELF ADJUSTMENT RAIL 400	kpl			4	
2-1-50-3	MA1134	HYLLYNSÄÄTÖKISKO 550 MARINE	SHELF ADJUSTMENT RAIL 550	kpl				4
2-1-50-4	MA1149	HYLLYNSÄÄTÖKISKO MR 2/2 MARINE	SHELF ADJUSTMENT RAIL MR 2/2	kpl	4			
2-1-51	MA1070	LANKAHYLLY MARINE	GRID SHELF	kpl	2	2	4	4
2-1-31-1	MA1072-3	OVITIIVISTE MF300 MARINE	DOOR GASKET 300	kpl		1		
2-1-31-2	MA1072-2	OVITIIVISTE MF400 MARINE	DOOR GASKET 400	kpl			1	
2-1-31-3	MA1072-1	OVITIIVISTE MF550 MARINE	DOOR GASKET 550	kpl				1
2-1-31-4	MA1072-4	OVITIIVISTE MR 2/2 MARINE	DOOR GASKET MR 2/2	kpl	1			
2-1-40-1	MA1028	OVIVALU KP 300 MARINE	DOOR 300	kpl		1		
2-1-40-2	MA1027	OVIVALU KP 400 MARINE	DOOR 400	kpl			1	
2-1-40-3	MA1026	OVIVALU KP 550 MARINE	DOOR 550	kpl				1
2-1-40-4	MA1029	OVIVALU KP MR2/2 MARINE	DOOR MR 2/2	kpl	1			
2-1-7	6300050	Sarana 160740 ty 402 ma kro	DOOR HINGE	kpl	2	2	2	2
2-1-8	MA1126	Vedin lu 160140 tyypp 517 MARI	DOOR HANDLE	kpl	1	1	1	1
2-1-23	7300033	HAIHDUTUSVASTUS 70W 240V	CONDENSATE HEATER	kpl				
2-1-22	7300115	SULATUSVASTUS 6W/240V/SILIKONI	DEFROST HEATER	kpl				
2-1-30	BL1030	TIIVISTEPROF.PIIR.BL1030/FUTURE	FRAME GASKET	M	2,7	3	3,5	4
2-1-14	3200063	SORMIRUUVI M5x18 musta	SCREW	kpl	2	2	2	2

2-1-15	3200074	SUODATIN 255x425x10 PPI-15	FILTER	kpl		1	1	1
2-1-16	MA1143	SUODATINLEVY MARINE	FILTER PLATE	kpl		1	1	1
2-1-17	MA1159	SUODATTIMEN KIINNITYSLANKA	FILTER FIXING CLIP	kpl		2	2	2
2-1-18	MA1186	VERHOLEVY YLÖS DIXELL MARINE	FRONT TOP PLATE	kpl	1	1	1	1
2-1-21-1	MA1071-6	LÄMPÖLANKA MF300 115 V MARINE	FRAME HEATER MF300 115V	kpl	1	1		
2-1-21-2	MA1071-5	LÄMPÖLANKA MF400 115 V MARINE	FRAME HEATER MF400 115V	kpl			1	
2-1-21-3	MA1071-4	LÄMPÖLANKA MF550 115 V MARINE	FRAME HEATER MF550 115V	kpl				1
2-1-20-1	GD1266	KARMIVASTUS 520 58W240V PET/TPR	FRAME HEATER	kpl				1
2-1-20-2	MA1071-3	KARMIVASTUS MF300 52W 230V	FRAME HEATER MF300 230V	kpl	1	1		
2-1-20-3	MA1071-2	KARMIVASTUS MF400 54W 230V	FRAME HEATER MF400 230V	kpl				1
2-1-3	8700098	LAIVAJALKA RST 2" H-140/200	MARINE LEG	kpl	4	4	4	4



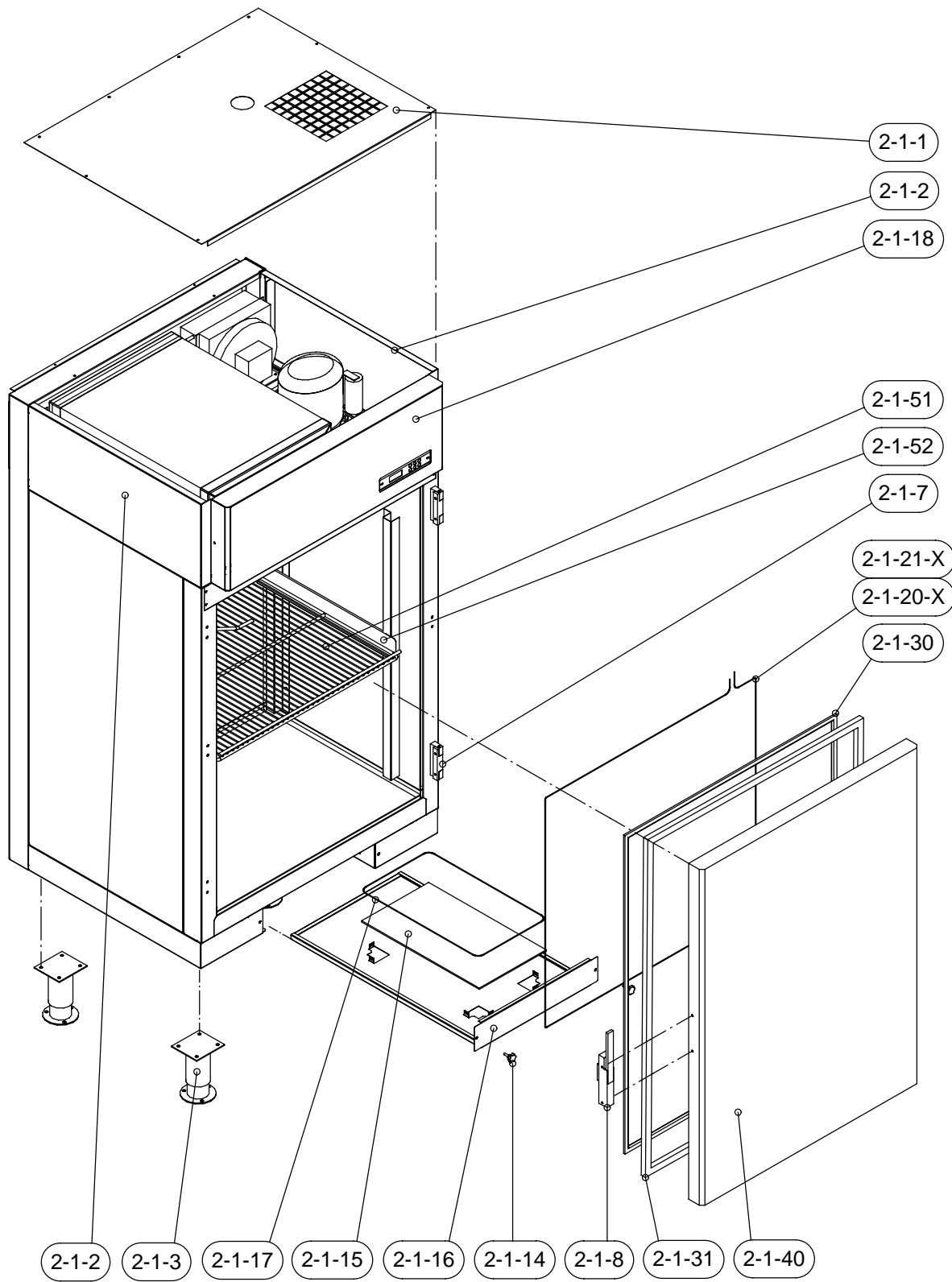

27.4.2007

VARA NRO	NIMIKE	NIMI	ARTICLE	YKS	kombi
2-2-1	MA1210	HYGIENIAKATTO MARINE 2/2 kombi	HYGIENIC TOP SEALING MRF2/2	kpl	1
2-2-2	MA1038	SIVUVERHOLEVY KONETILA HKP MAR	UPPER SIDE PANEL	kpl	2
2-2-52	MA1137	HYLLYNKANNATIN MARINE	SHELF HOLDER	kpl	8
2-2-50	MA1149	HYLLYNSÄÄTÖKISKO MR 2/2 MARINE	SHELF ADJUSTMENT RAIL MRF2/2	kpl	8
2-2-51	MA1070	LANKAHYLLY MARINE	GRID SHELF	kpl	4
2-2-31	MA1072-4	OVITIIVISTE MR 2/2 MARINE	DOOR GASKET MR2/2	kpl	2
2-2-40	MA1029	OVIVALU KP MR2/2 MARINE	DOOR MR2/2	kpl	2
2-2-7	6300050	Sarana 160740 ty 402 ma kro	DOOR HINGE	kpl	4
2-2-8	MA1126	Vedin lu 160140 tyypp 517 MARI	DOOR HANDLE	kpl	2
2-2-23	7300033	HAIHDUTUSVASTUS 70W 240V	CONDENSATE HEATER	kpl	1
2-2-9	MA1033	KESKIKARMI HKP MR 2/2 MARINE	MIDDLE FRAME	kpl	1
2-2-3	8700098	LAIVAJALKA RST 2" H-140/200	MARINE LEG	kpl	4
2-2-22	7300115	SULATUSVASTUS 6W/240V/SILIKONI	DEFROST HEATER	kpl	1
2-2-30	BL1030	TIIVISTEPROF.PIIR.BL1030/FUTURE	FRAME GASKET	M	5,5
2-2-20	GD1266	KARMIVASTUS 520 58W240V PET/TPR	FRAME HEATER	kpl	1
2-2-14	3200063	SORMIRUUVI	SCREW	kpl	1
2-2-15	MA1187	VERHOLEVY	FRONT TOP PLATE	kpl	1

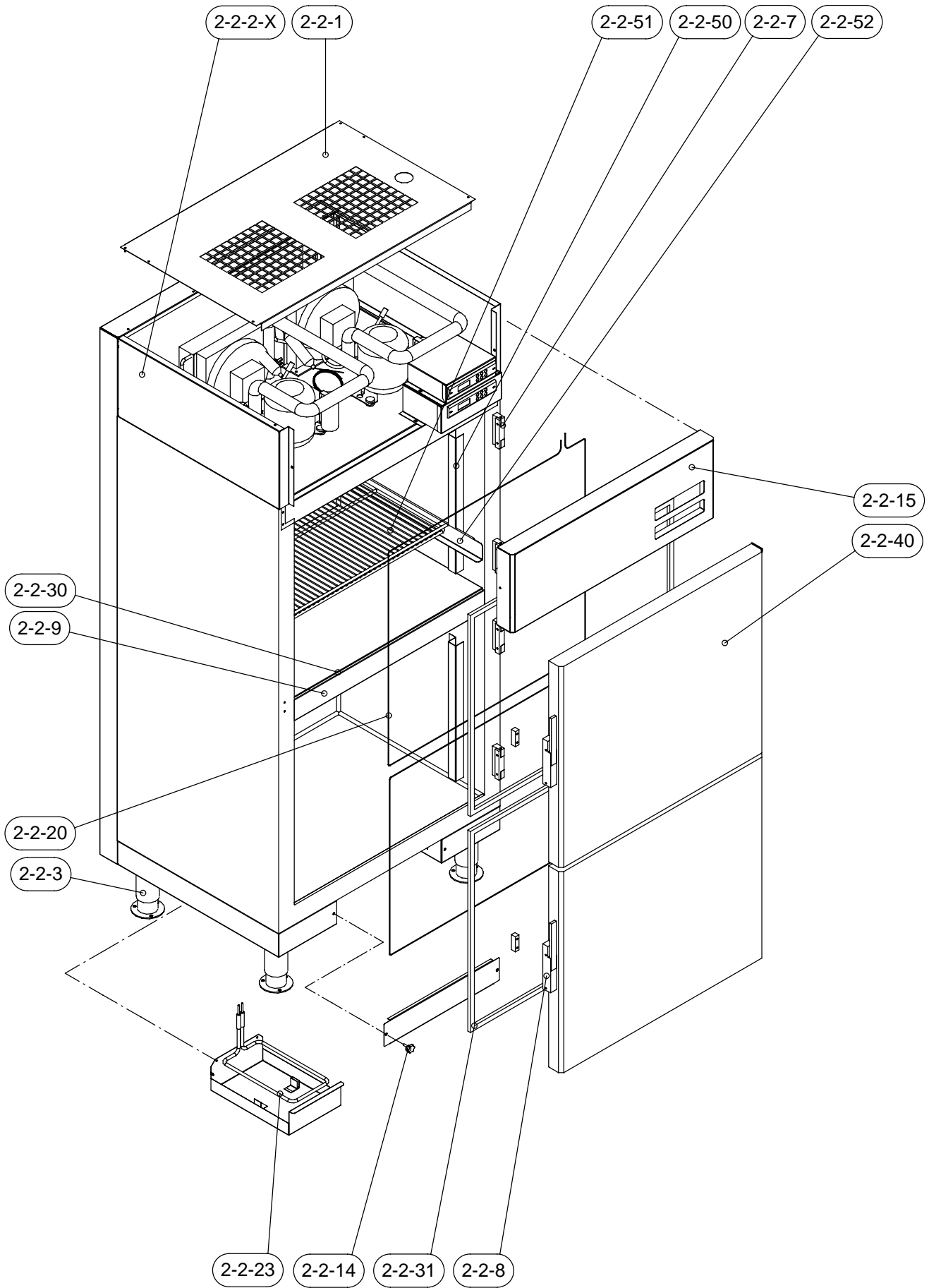

27.4.2007

OSA NO.	NIMIKE	NIMI	YKS	MR200- MR550 230V	MR200- MR550 115V	MF200 - MF400 230 V	MF550 230 V	MF200 - MF400 115 V	MF550 115 V
2-3-60	6000469	MAGN-VENT.RUNKO EVR3 J.	KPL			1	1	1	1
2-3-61-2	6000477	KELA EVR:LLE IP67 018F6280	KPL					1	1
2-3-61-1	6000498	KELA EVR 3-Ile 220v/50Hz 10w	KPL			1	1		
2-3-63	1700029	KAPILLAARIPUTKI 1.24X2.51/SOFT	KPL	1	1	1	1	1	1
2-3-51	5000038	LAITEPUHALLIN 120x120x38/230V	KPL	1		1	1		
2-3-50	5000044	LAITEPUHALLIN 120x120x38/115V	KPL		1			1	1
2-3-64	6000013	JLKIHYRYSTIN 30X150mm	KPL	1	1	1	1	1	1
2-3-30	6001045	HÖYRYSTIN ECO PS28BAR G2 MARI	KPL	1	1	1	1	1	1
2-3-65	MA1045	HÖYRYSTINKOTELO MARINE	kpl	1	1	1	1	1	1
2-3-66	MA1182	TIPPUVESIALLAS MARINE 300-550	kpl	1	1	1	1	1	1
2-3-10	6200190	Kompressori ML60TG 01100011	KPL	1					
2-3-11	6200191	Kompressori MP12FG 01100093	KPL			1			
2-3-12	6200192	Kompressori MP14FG 01100097	KPL				1		
2-3-13	6200195	Kompressori ML60TR 01100012	KPL		1				
2-3-14	6200196	Kompressori MP12FR 01100094	KPL					1	
2-3-15	6200197	Kompressori MP14FE 01100098	KPL						1
2-3-67	6000076	KAPILLAARIKUIVAIN 30g R134a	KPL	1	1	1	1	1	1
2-3-20	6100003	LAUHDUTIN STVF 100	KPL	1	1	1	1	1	1
2-3-21	6100390	LAUHDUTIN STVF 67	KPL						
2-3-68	MA1035	HAIHDUTUSALLAS HKP	KPL	1	1	1	1	1	1
2-3-69	7200010	VERKKOJOHTO 5M MSK 3X1.5	KPL	1	1	1	1	1	1
2-3-40-1	7500270	TERM.SÄÄDIN XW60L-5N1C1/DIXELL	KPL	1		1	1		
2-3-41	MA1076	ANTURI 1,5 NS6	KPL	2	2	2	2	2	2
2-3-42	MA1077	ANTURI,1.1 MT NG6P HÖYRYSTIN	KPL	1	1	1	1	1	1
2-3-40-2	7500271	TERM.SÄÄDIN XW60L-4N1C1/DIXELL	KPL		1			1	1

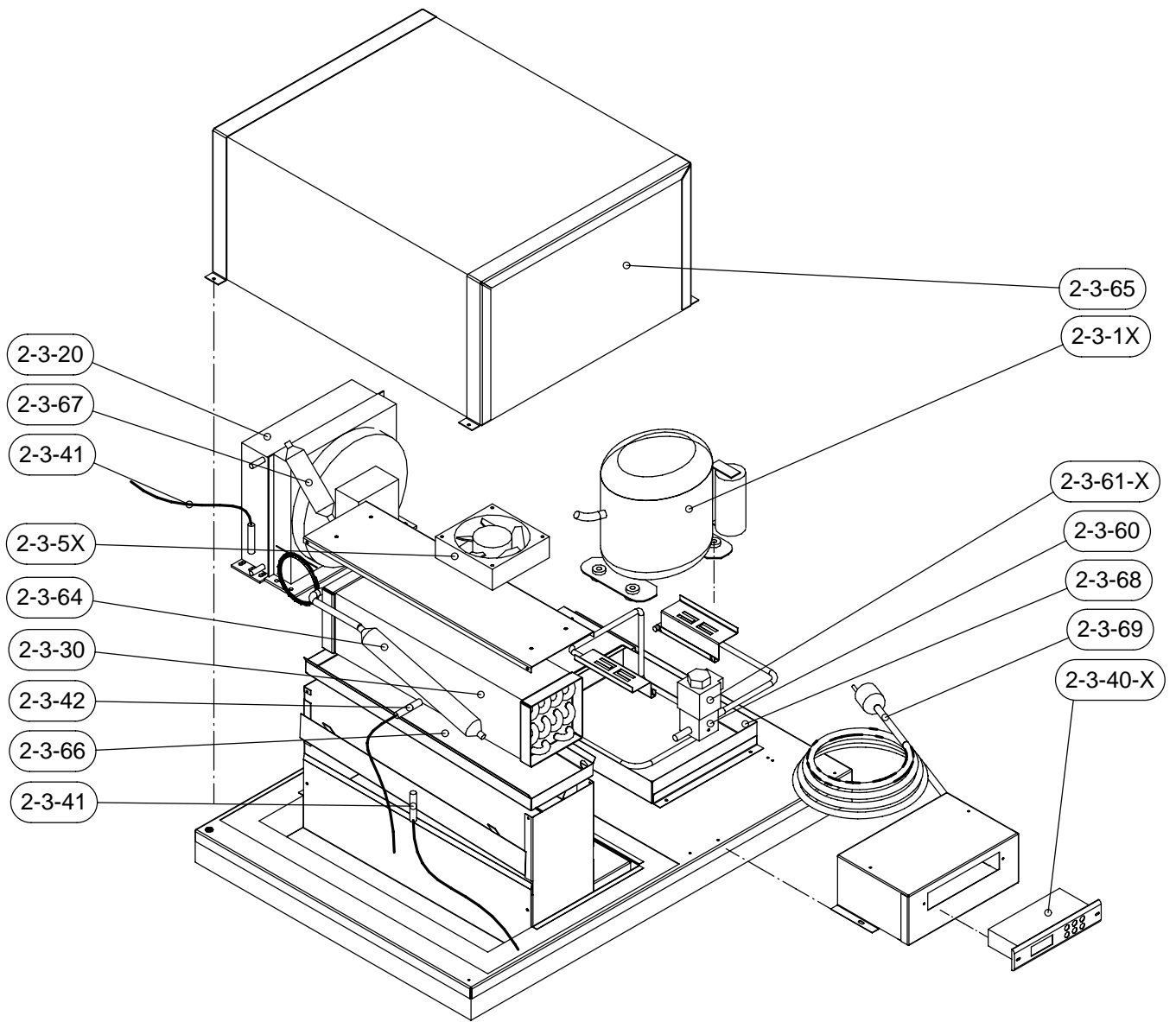

27.4.2007

27.4.2007

varaosa

NRO	NIMIKE	NIMI	ARTICLE	YKS	MR/F 2/2
2-4-60	1700029	KAPILLAARIPUTKI 1.24X2.51/SOFT	CAPILLARY TUBE	KPL	1
2-4-61	6000013	J[LKIH\YRYSTIN 30X150mm	SUCTION ACCUMULATOR	KPL	2
2-4-62	1700075	KAPILLAARIPUTKI 1.06x2.36/SOFT	CAPILLARY TUBE	KPL	1
2-4-10	6200193	Kompressori ML40TG 01100003	COMPRESSOR	KPL	1
2-4-11	6200194	Kompressori ML80FG 01100085	COMPRESSOR	KPL	1
2-4-63	6000076	KAPILLAARIKUIVAIN 30g R134a	FILTER DRIER	KPL	2
2-4-20	6100003	LAUHDUTIN STVF 100	CONDENSER	KPL	1
2-4-21	6100390	LAUHDUTIN STVF 67	CONDENSER	KPL	1
2-4-64	MA1035	HAIHDUTUSALLAS HKP	CONDENSATE TRAY	KPL	
2-4-65	7200010	VERKKOJOHTO 5M MSK 3X1.5	POWER CORD	KPL	
2-4-40	7500270	TERM.SÄÄDIN XW60L-5N1C1/DIXELL	CONTROL UNIT	KPL	2
2-4-42	MA1076	ANTURI 1.5,NS6 LAUHDUTIN	CONDENSING TEMP. SENSOR	KPL	1
2-4-43	MA1077	ANTURI,1.1 MT NG6P HÖYRYSTIN	DEFROST TEMP. SENSOR	KPL	1
2-4-44	MA1080	ANTURI 2.5 MT NS6 ILMATILA	TEMP. CONTROL SENSOR	KPL	1
2-4-45	MA1081	ANTURI 2.5 MT NG6P HÖYRYSTIN	DEFROST TEMP. SENSOR	KPL	1

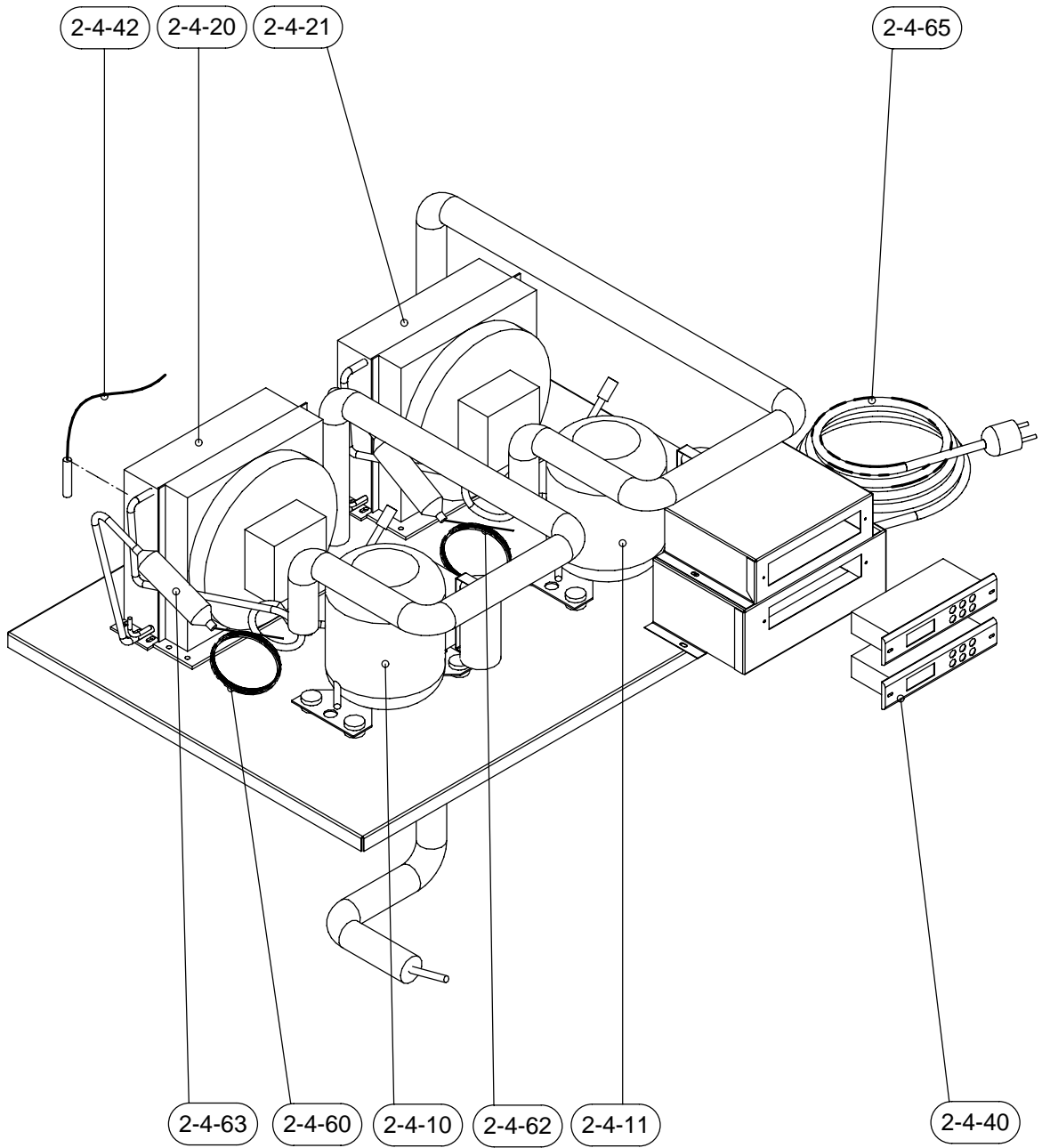



24.7.07

varaosa

NRO	NIMIKE	NIMI	ARTICLE	YKS	MR200- MR550 230V	MR200- MR550 115V	MF200 - MF400 230 V	MF550 230 V	MF200 - MF400 115 V	MF550 115 V	MR/F 2/2
2-5-61	6000013	J[LKIHRYSTIN 30X150mm	SUCTION ACCUMULATOR	KPL	1	1	1	1	1	1	2
2-5-40	6001043	HRYSTIN EVS 40B-ED	EVAPORATOR	KPL							1
2-5-42	7600008	Puhallin	FAN MOTOR	KPL							
2-5-43	7300036	Sulatusvastus	DEFROST HEATER	KPL							
2-5-41	6001044	HRYSTIN EVS 40	EVAPORATOR	KPL							1
2-5-42	7600008	Puhallin	FAN MOTOR	KPL							
2-5-60	MA2251	Höyrystinputki 2/2	EVAPORATOR TUBE	KPL							2
2-5-50	MA1080	ANTURI 2.5 MT NS6 ILMATILA	TEMP. CONTROL SENSOR	KPL							1
2-5-51	MA1081	ANTURI 2.5 MT NG6P HÖYRYSTIN	DEFROST TEMP. SENSOR	KPL							1

